



O-ONE SOFA



Structure

Multilayered Norwegian pine.

Padding

Back and arm rests: cover fabric 100% white cotton.

Filler: 50% goose down and 50% silicone flakes, polyurethane T40 PK + T35 S.

Seat cushions: cover fabric 100% white cotton, inner fabric 65% polyester 35% cotton.

Filler: 100% goose and duck down, polyurethane T40 PFM.

Back cushions: cover fabric resin-treated 100gr 100% white cotton, inner fabric: 65% polyester 35% cotton.

Filler: 50% goose down and 50% silicone flakes, polyurethane T40 TD.

Base: cover fabric 100% white cotton.

Filler: 50% goose down and 50% silicone flake.

Upholstery

Range of leather, nappa and other fabrics as per samples, extra decorative cushions in leather and nappa as per samples or in natural fabrics from the sample collections.

Metal Base

Hand burnished black steel base made using traditional techniques.

Hand burnished brass base made using traditional techniques.

DIMENSIONS

110 cm x 70 cm

H seat: 37 cm

H base: 8 cm

Struttura

Multistrato di conifera norvegese.

Imbottitura

Schienale e bracciolo: tessuto esterno 100% cotone bianco.

Interno: 50% piuma d'oca e 50% fiocco siliconato, poliuretano T40 PK + T35 S.

Seduta: tessuto esterno 100% cotone bianco, tessuto interno 65% poliestere 35% cotone.

Interno: 100% piuma d'oca, d'anatra, poliuretano T40 PFM.

Cuscino schienale: tessuto esterno 100% cotone bianco resinato 100 gr, tessuto interno: 65% poliestere 35% cotone.

Interno: 50% piuma d'oca e 50% fiocco siliconato, poliuretano T40 TD.

Basamento: tessuto esterno 100% cotone bianco.

Interno: 50% piuma d'oca e 50% fiocco siliconato.

Rivestimenti

Gamma pelli, nappa e tessuti a campionario, cuscinate aggiuntive e decorative in pelle e nappa a campionario o nei tessuti naturali delle collezioni a campionario.

Basamento Metallo

Acciaio brunito nero a mano secondo le tecniche tradizionali.

Ottone brunito a mano secondo le tecniche tradizionali.

DIMENSIONI

110 cm x 70 cm

H seduta: 37 cm

H base: 8 cm

Two-seater sofa . Divano 2 posti 220

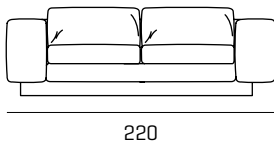

Two-seater maxi sofa . Divano 2 posti maxi 260

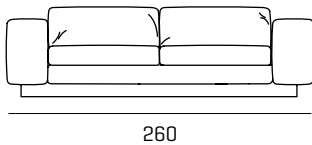

Three-seater sofa . Divano 3 posti 300

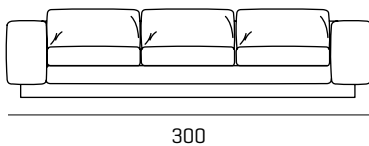

Three-seater maxi sofa . Divano 3 posti maxi 360

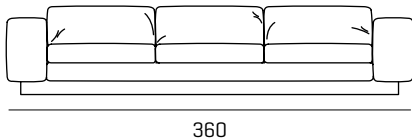

Two-seater element Lh-Rh . Elemento 2 posti 190 Sx-Dx

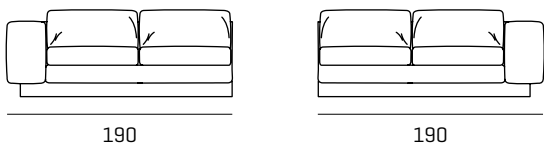

Two-seater large element Lh-Rh . Elemento 2 posti maxi 230 Sx-Dx

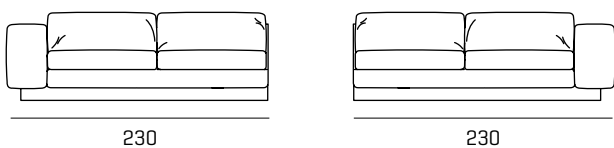

One seater element Lh-Rh . Elemento 1 posto 110 Sx-Dx

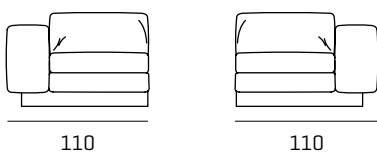

One seater large element Lh-Rh . Elemento finale maxi 130 Sx-Dx

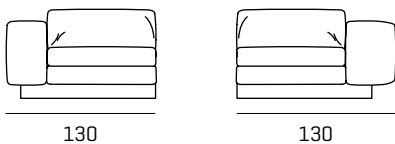

Two-seater element Lh-Rh . Elemento 2 posti 190 Sx-Dx

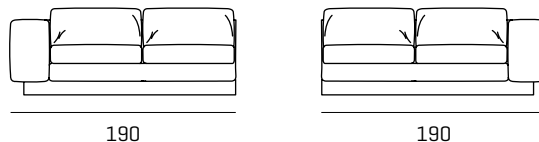

Two-seater large element Lh-Rh . Elemento 2 posti maxi 230 Sx-Dx

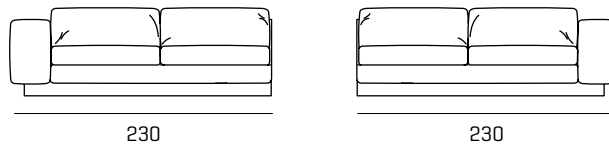

One seater element Lh-Rh . Elemento 1 posto 110 Sx-Dx

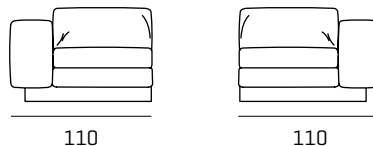

One seater large element Lh-Rh . Elemento finale maxi 130 Sx-Dx

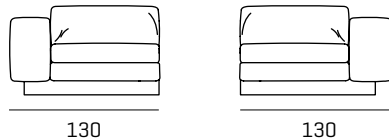

Peninsula Lh-Rh . Penisola 110x180 Sx-Dx

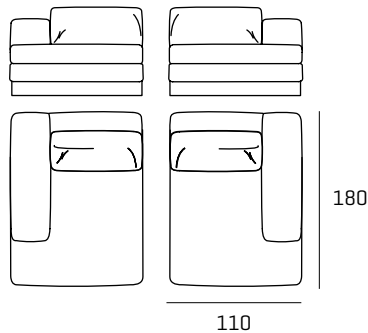

Corner . Angolo 110x110

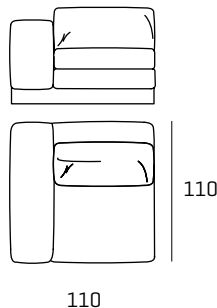

Central element . Elemento centrale 80

